

A

B

C

D

E

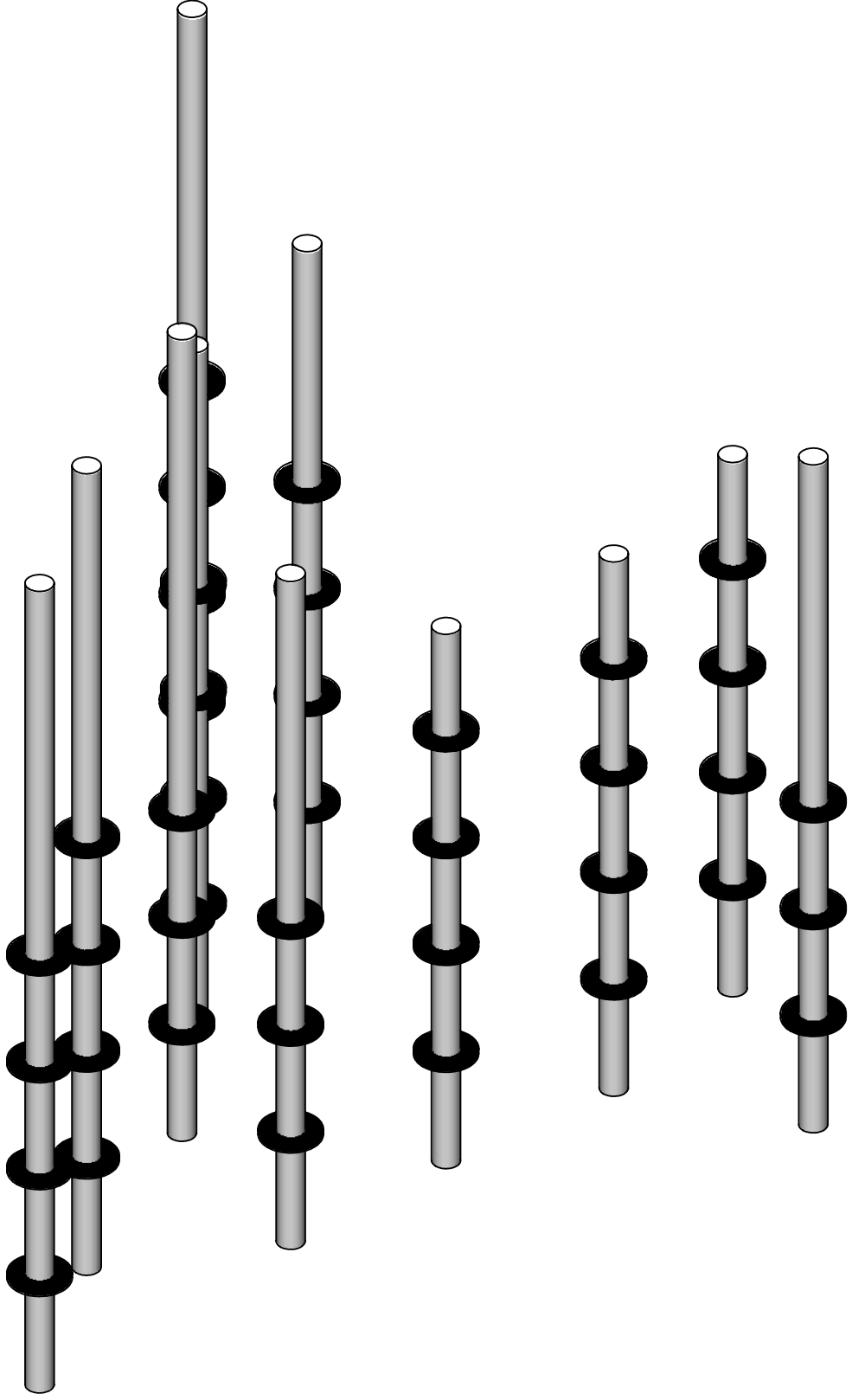

UNLESS OTHERWISE SPECIFIED:
 DIMENSIONS ARE IN MILLIMETERS
 WEIGHT ARE IN KILOGRAMM

PART NUMBER / DWG NO.: **KRS4 MF**

	NAME	SIGNATURE	DATE	REVISION
DRAWN	E.Reispere		10.10.2024	
APPV'D				

DESCRIPTION:
STRAW set with climbing steps 11 pcs.



MATERIAL:	metal, plastic	A4
WEIGHT:	SCALE: 1:20	SHEET 1 OF 7

A

B

C

D

E

F

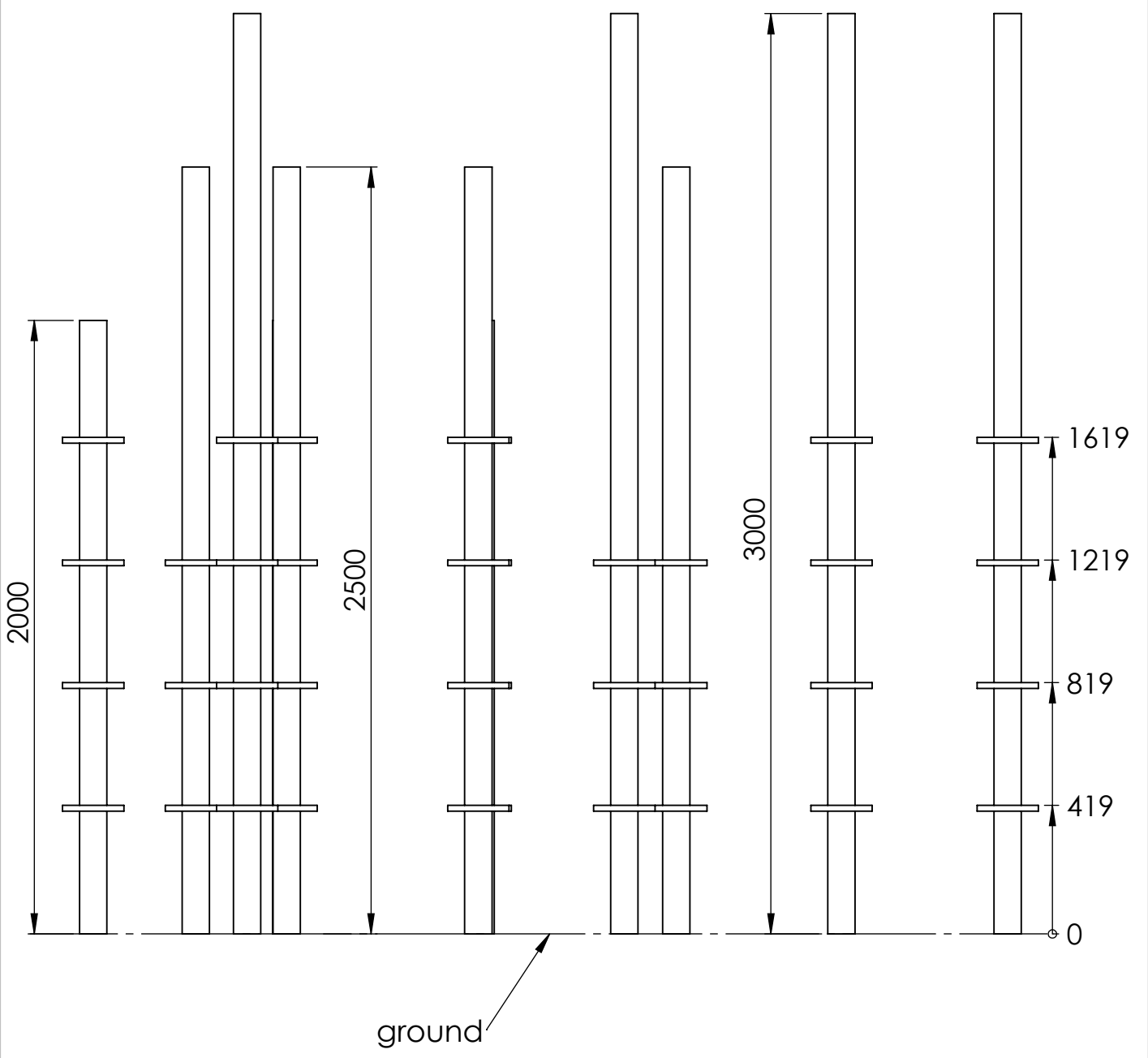

UNLESS OTHERWISE SPECIFIED:
 DIMENSIONS ARE IN MILLIMETERS
 WEIGHT ARE IN KILOGRAMM

	NAME	SIGNATURE	DATE	REVISION
DRAWN	E.Reispere		10.10.2024	
APPV'D				

PART NUMBER / DWG NO.:
KRS4 MF

DESCRIPTION:
STRAW set with climbing steps 11 pcs.



MATERIAL:	metal, plastic	A4
WEIGHT:	SCALE: 1:20	SHEET 2 OF 7

A

B

C

D

E

F

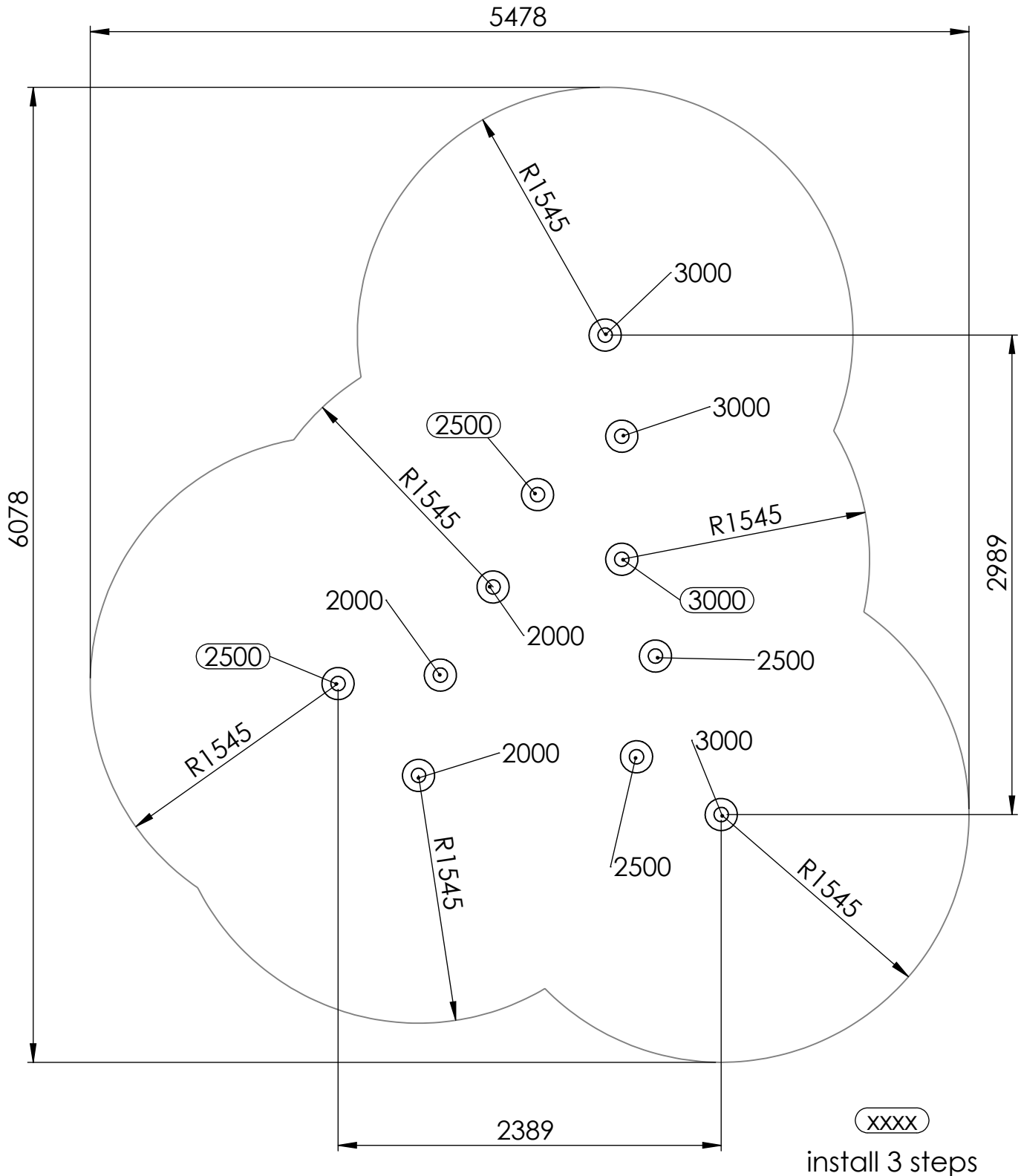

UNLESS OTHERWISE SPECIFIED: DIMENSIONS ARE IN MILLIMETERS WEIGHT ARE IN KILOGRAMM				
	NAME	SIGNATURE	DATE	REVISION
DRAWN	E.Reispere		10.10.2024	
APPV'D				

PART NUMBER / DWG NO.: **KRS4 MF**

DESCRIPTION:
STRAW set with climbing steps 11 pcs.



MATERIAL:	metal, plastic	A4
WEIGHT:	SCALE: 1:30	SHEET 3 OF 7

A

B

C

D

E

F

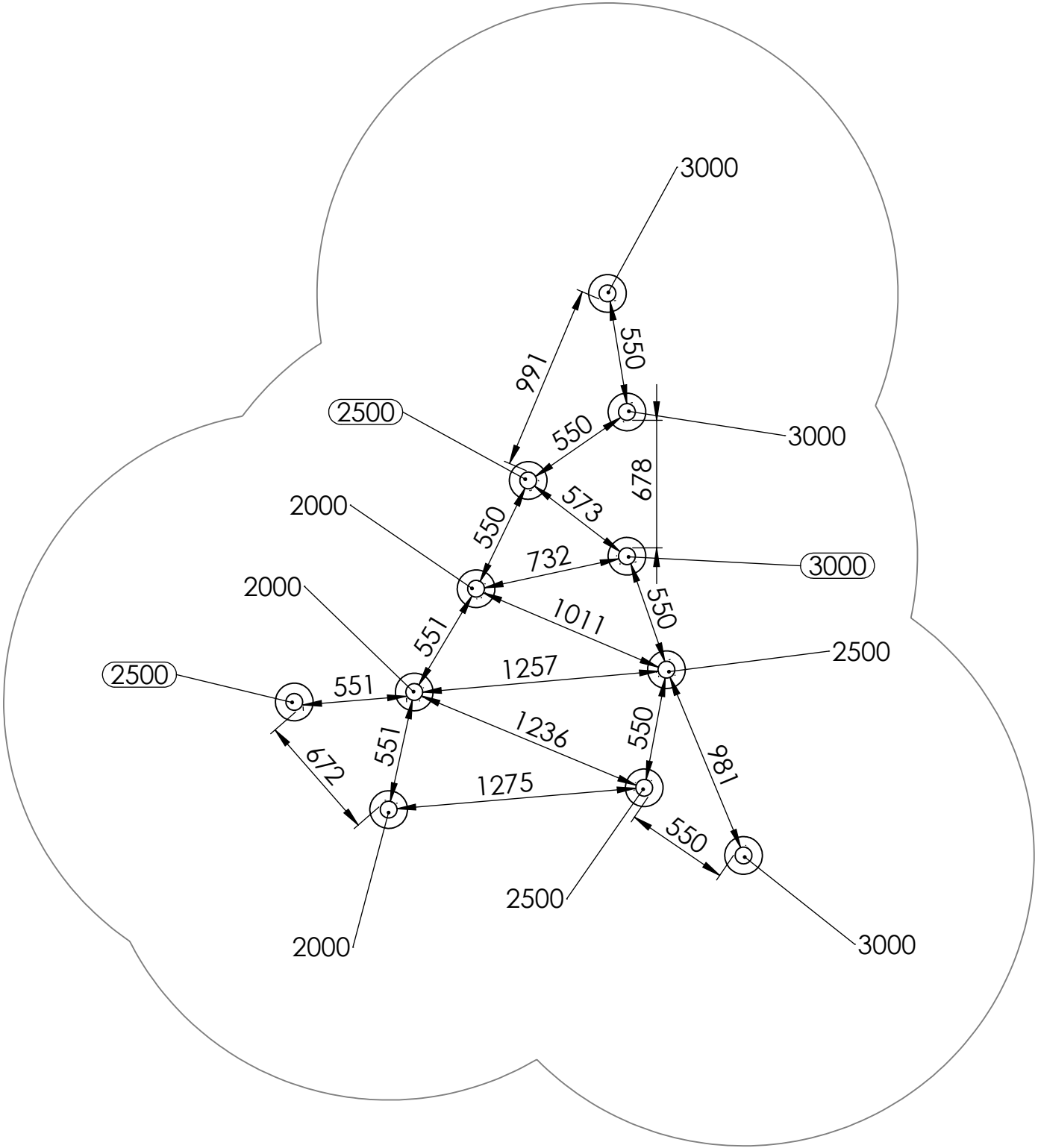

XXXX

install 3 steps

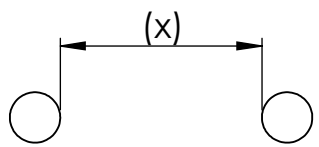

UNLESS OTHERWISE SPECIFIED: DIMENSIONS ARE IN MILLIMETERS WEIGHT ARE IN KILOGRAMM				
	NAME	SIGNATURE	DATE	REVISION
DRAWN	E.Reispere		10.10.2024	
APPV'D				

PART NUMBER / DWG NO.: **KRS4 MF**

DESCRIPTION:
STRAW set with climbing steps 11 pcs.



MATERIAL:	metal, plastic	A4
WEIGHT:		
	SCALE: 1:30	SHEET 4 OF 7

foundation

A

B

C

D

E

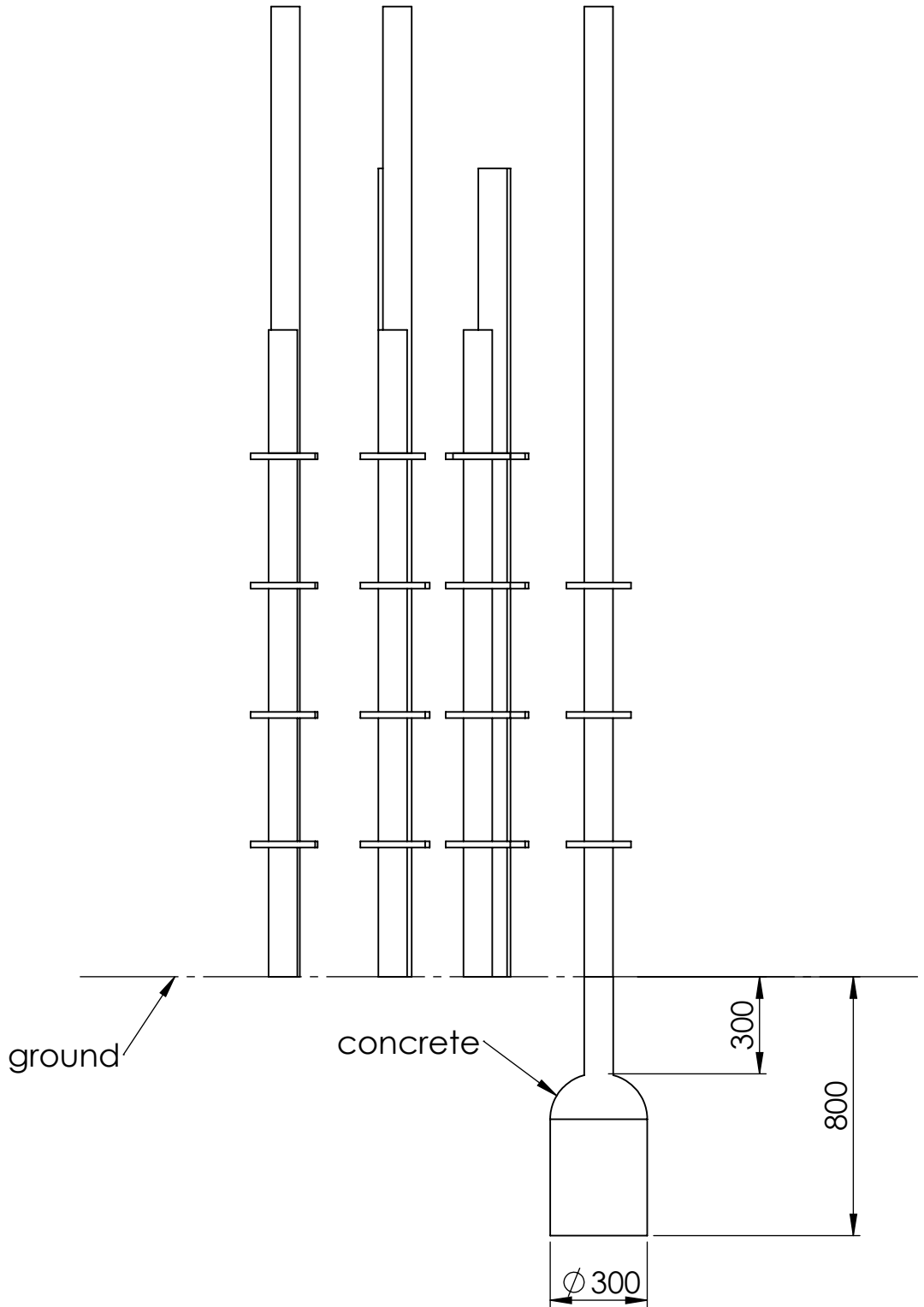

UNLESS OTHERWISE SPECIFIED: DIMENSIONS ARE IN MILLIMETERS WEIGHT ARE IN KILOGRAMM				
	NAME	SIGNATURE	DATE	REVISION
DRAWN	E.Reispere		10.10.2024	
APPV'D				

PART NUMBER / DWG NO.: **KRS4 MF**

DESCRIPTION:
STRAW set with climbing steps 11 pcs.



MATERIAL:	metal, plastic	A4
WEIGHT:	SCALE: 1:20	SHEET 5 OF 7

A

B

C

D

E

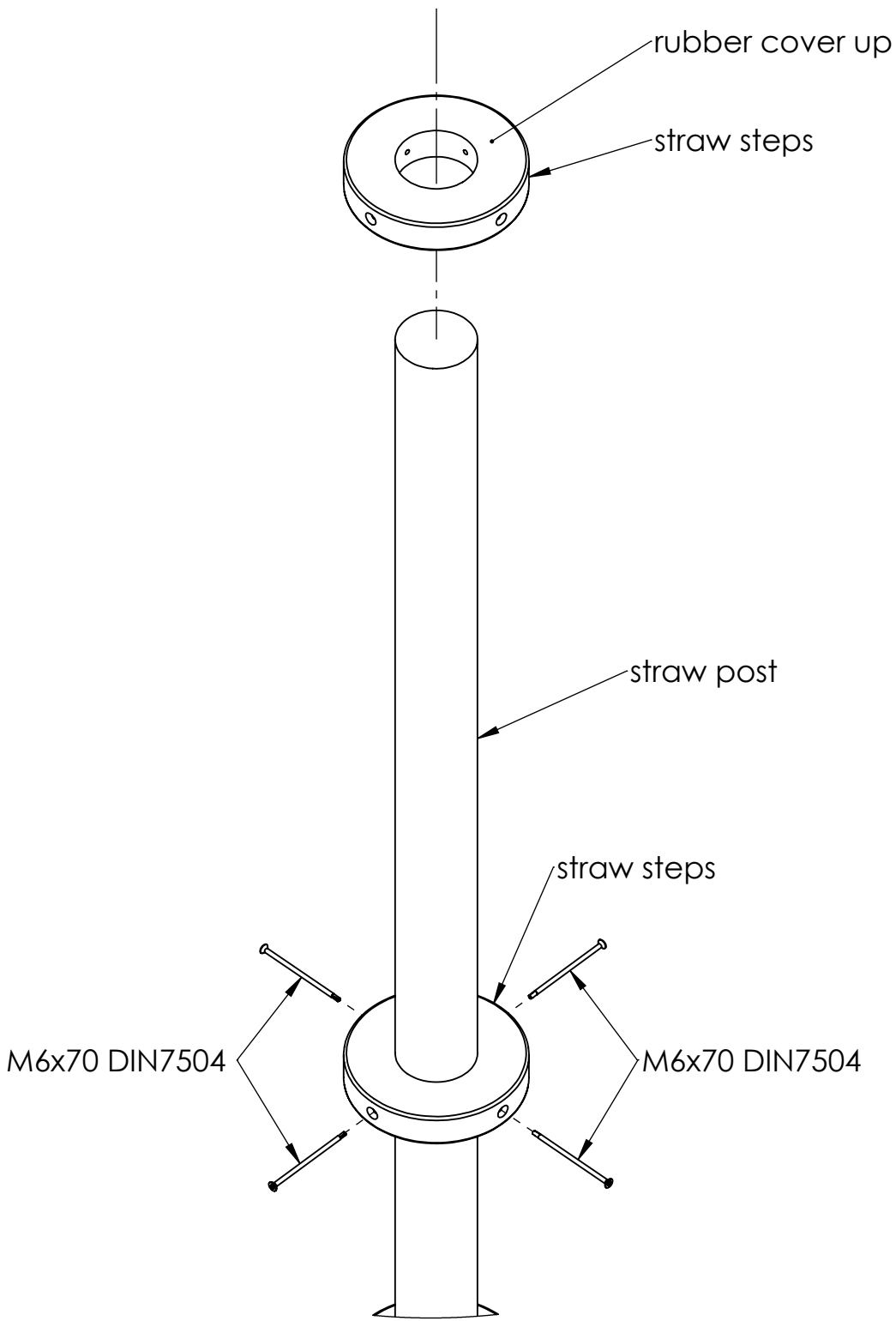

UNLESS OTHERWISE SPECIFIED:
 DIMENSIONS ARE IN MILLIMETERS
 WEIGHT ARE IN KILOGRAMM

PART NUMBER / DWG NO.:

KRS4 MF

	NAME	SIGNATURE	DATE	REVISION
DRAWN	E.Reispere		10.10.2024	
APPV'D				

DESCRIPTION:

STRAW set with climbing steps 11 pcs.

F



Tiptiptap^{ÖÜ}

MATERIAL:

metal, plastic

A4

WEIGHT:

SCALE: 1:30

SHEET 6 OF 7

A

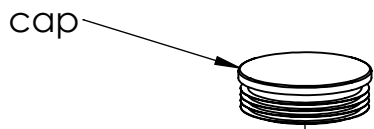

B

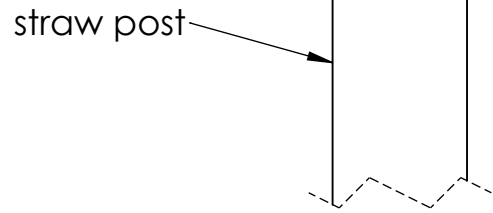

C

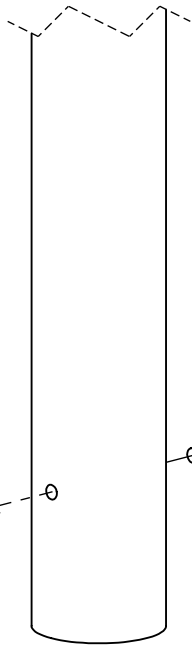

bolt M10x110 DIN 931



D

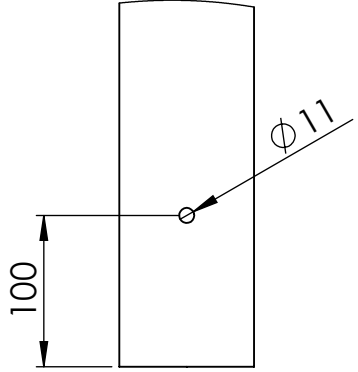
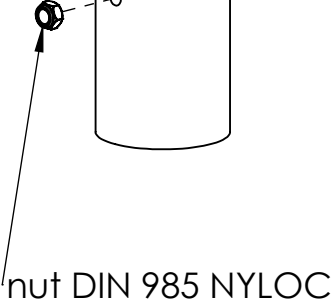

E

F

UNLESS OTHERWISE SPECIFIED:
DIMENSIONS ARE IN MILLIMETERS
WEIGHT ARE IN KILOGRAMM

	NAME	SIGNATURE	DATE	REVISION
DRAWN	E.Reispere		10.10.2024	
APPV'D				



Tiptiptap ^{OO}

PART NUMBER / DWG NO.:		KRS4 MF	
DESCRIPTION:			
STRAW set with climbing steps 11 pcs.			
MATERIAL:		metal, plastic	A4
WEIGHT:		SCALE: 1:30	SHEET 7 OF 7