

1

2

3

4

A

B

C

D

E

F

UNLESS OTHERWISE SPECIFIED:  
DIMENSIONS ARE IN MILLIMETERS  
WEIGHT ARE IN KILOGRAMM

PART NUMBER / DWG NO.:

KRS3

	NAME	SIGNATURE	DATE	REVISION
DRAWN	E.Reispere		14.06.2022	
APPV'D				

DESCRIPTION:

STRAW set 11 pcs.



**Tiptiptap** OÜ

Tiptiptap OÜ  
Veetorni 9,  
Jüri alevik, Rae vald,  
75301 Harjumaa

MATERIAL:

metal, plastic

A4

WEIGHT:

SCALE: 1:35

SHEET 1 OF 6

A

B

C

D

E

F

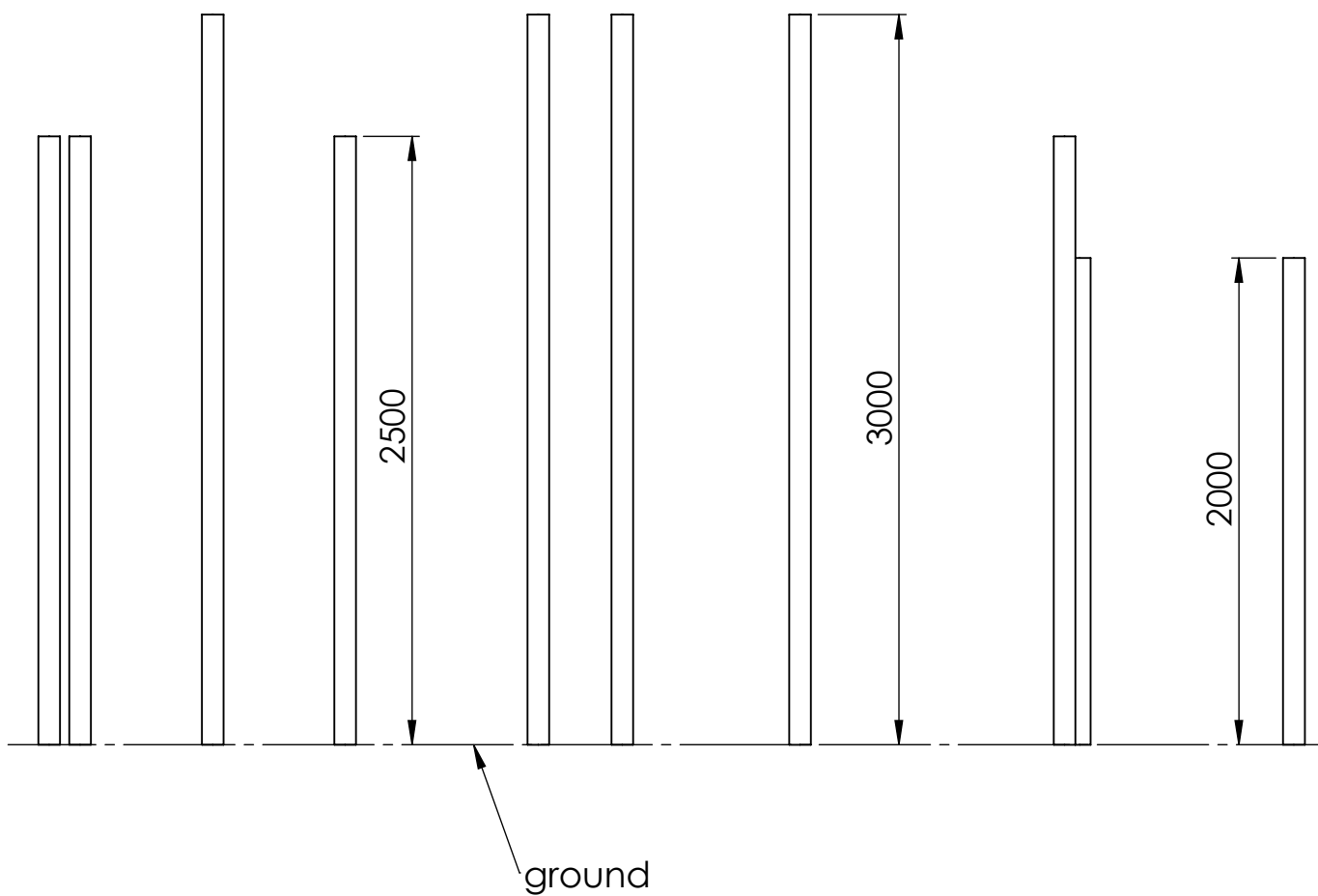

UNLESS OTHERWISE SPECIFIED:  
DIMENSIONS ARE IN MILLIMETERS  
WEIGHT ARE IN KILOGRAMM

PART NUMBER / DWG NO.:

KRS3

	NAME	SIGNATURE	DATE	REVISION
DRAWN	E.Reispere		14.06.2022	
APPV'D				

DESCRIPTION:

STRAW set 11 pcs.



**Tiptiptap** OÜ

Tiptiptap OÜ  
Veetorni 9,  
Jüri alevik, Rae vald,  
75301 Harjumaa

MATERIAL:

metal, plastic

A4

WEIGHT:

SCALE: 1:30

SHEET 2 OF 6

# safety area

A

B

C

D

E

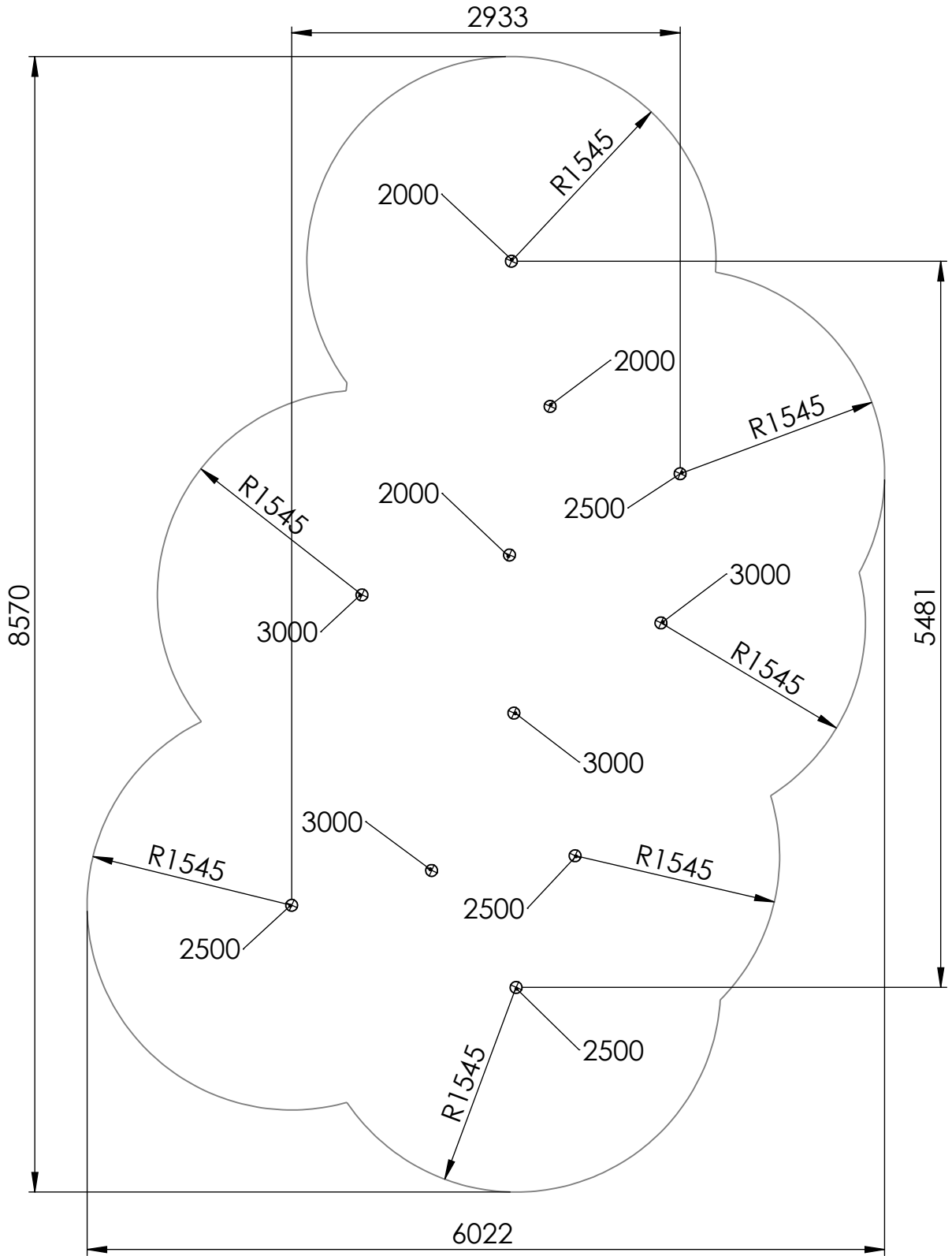

UNLESS OTHERWISE SPECIFIED:  
DIMENSIONS ARE IN MILLIMETERS  
WEIGHT ARE IN KILOGRAMM

PART NUMBER / DWG NO.:

KRS3

	NAME	SIGNATURE	DATE	REVISION
DRAWN	E.Reispere		14.06.2022	
APPV'D				

DESCRIPTION:

STRAW set 11 pcs.

F



**Tiptiptap** OÜ

Tiptiptap OÜ  
Veetorni 9,  
Jüri alevik, Rae vald,  
75301 Harjumaa

MATERIAL:

metal, plastic

A4

WEIGHT:

SCALE: 1:40

SHEET 3 OF 6

# foundation

A

B

C

D

E

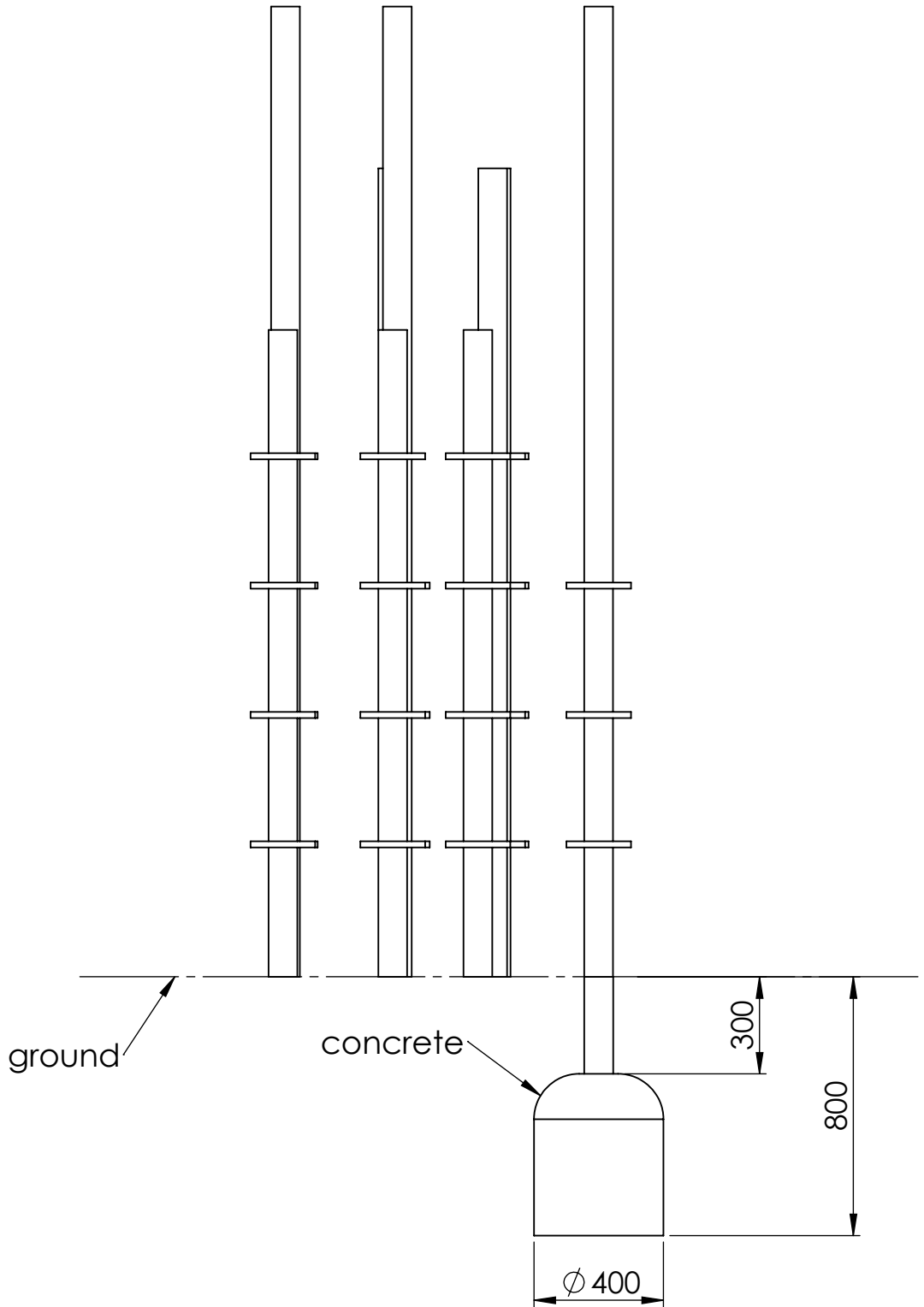

UNLESS OTHERWISE SPECIFIED: DIMENSIONS ARE IN MILLIMETERS WEIGHT ARE IN KILOGRAMM				
	NAME	SIGNATURE	DATE	REVISION
DRAWN	E.Reispere		14.06.2022	
APPV'D				

PART NUMBER / DWG NO.:	KRS3
DESCRIPTION:	STRAW set 11 pcs.



MATERIAL:	metal, plastic	A4
WEIGHT:	SCALE: 1:20	SHEET 4 OF 6

A

B

C

D

E

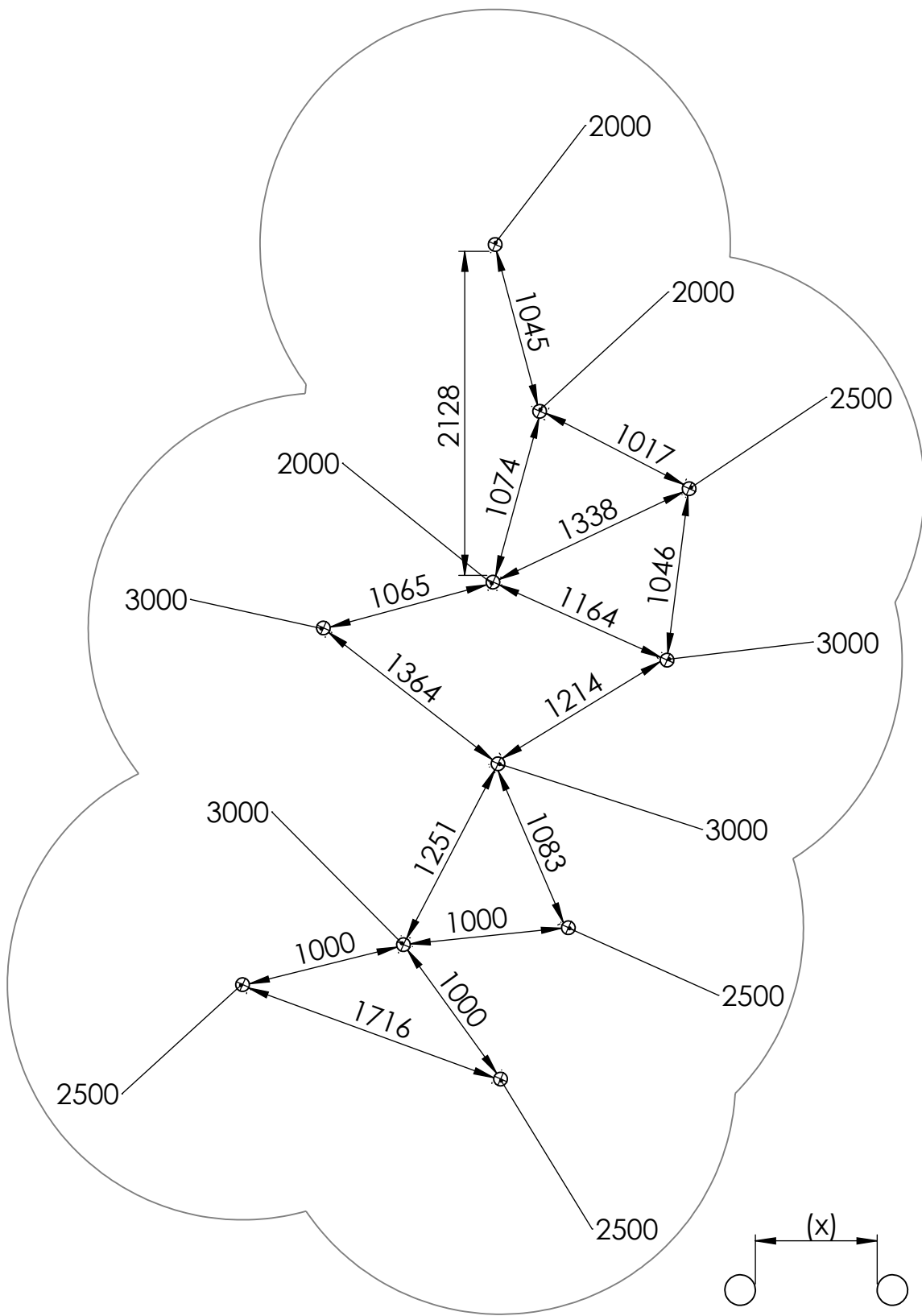

UNLESS OTHERWISE SPECIFIED:  
 DIMENSIONS ARE IN MILLIMETERS  
 WEIGHT ARE IN KILOGRAMM

PART NUMBER / DWG NO.:  
**KRS3**

	NAME	SIGNATURE	DATE	REVISION
DRAWN	E.Reispere		14.06.2022	
APPV'D				

DESCRIPTION:  
**STRAW set 11 pcs.**



**Tiptiptap** OÜ  
 Veetorni 9,  
 Jüri alevik, Rae vald,  
 75301 Harjumaa

MATERIAL:	metal, plastic	A4
WEIGHT:	SCALE: 1:40	SHEET 5 OF 6

A

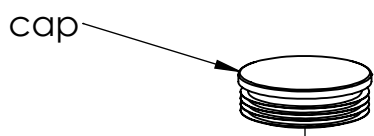

B

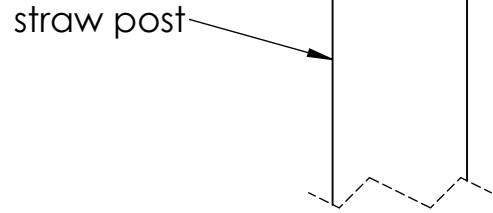

C

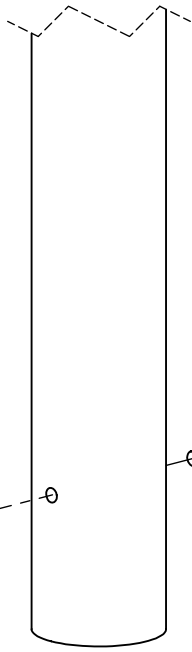

bolt M10x110 DIN 931

D

nut DIN 985 NYLOC

E

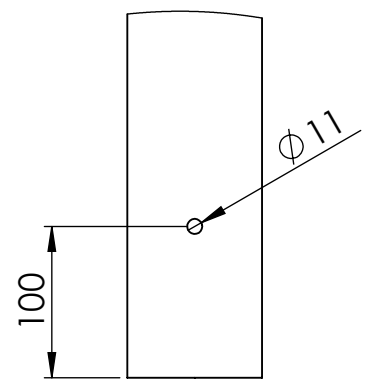

UNLESS OTHERWISE SPECIFIED:  
 DIMENSIONS ARE IN MILLIMETERS  
 WEIGHT ARE IN KILOGRAMM

PART NUMBER / DWG NO.:  
**KRS3**

	NAME	SIGNATURE	DATE	REVISION
DRAWN	E.Reispere		14.06.2022	
APPV'D				

DESCRIPTION:  
**STRAW set 11 pcs.**



**Tiptiptap** OÜ  
 Veetorni 9,  
 Jüri alevik, Rae vald,  
 75301 Harjumaa

MATERIAL: metal, plastic

A4

WEIGHT: SCALE: 1:30 SHEET 6 OF 6