

A

B

C

D

E

F

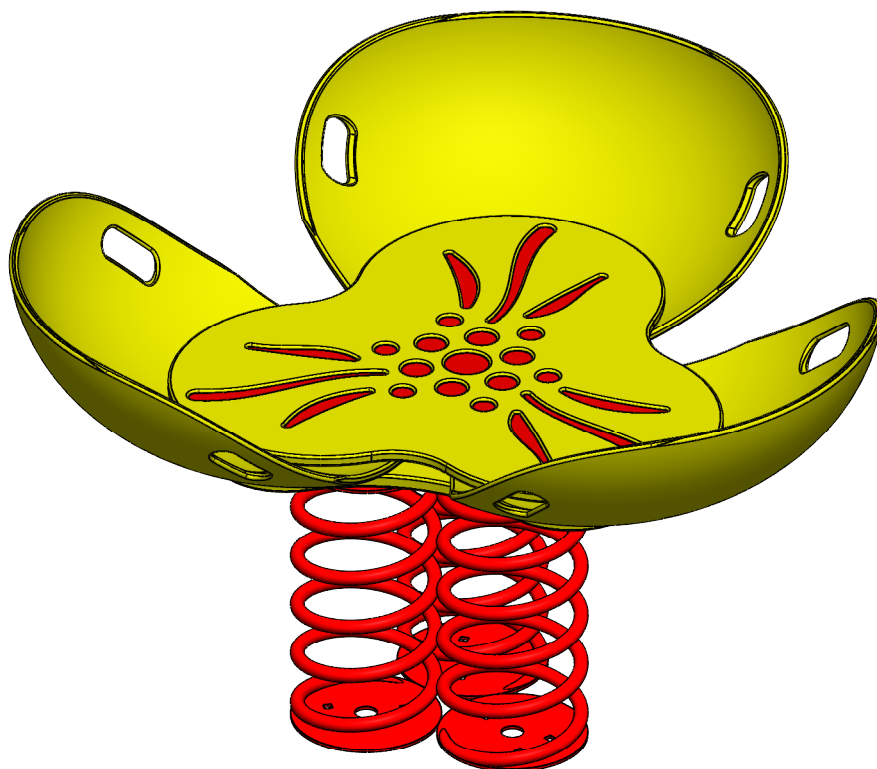

UNLESS OTHERWISE SPECIFIED:
DIMENSIONS ARE IN MILLIMETERS
WEIGHT ARE IN KILOGRAMM

PART NUMBER / DWG NO.:

VLI56

	NAME	SIGNATURE	DATE	REVISION
DRAWN	E.Reispere		28.01.2021	
APPV'D				

DESCRIPTION:

Spring swing LILY



Tiptaptap OÜ

Tiptaptap OÜ
Veetorni 9,
Jüri alevik, Rae vald,
75301 Harjumaa

MATERIAL:

wood, metal, plastic

A4

WEIGHT:

SCALE: 1:10

SHEET 1 OF 5

safety area

A

B

C

D

E

F

1170

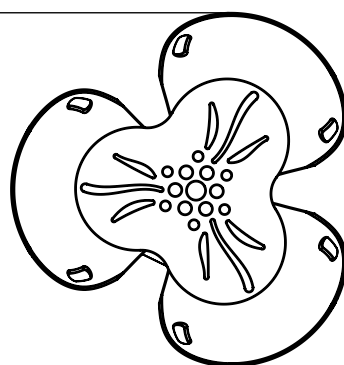
 Φ 3570

UNLESS OTHERWISE SPECIFIED:
DIMENSIONS ARE IN MILLIMETERS
WEIGHT ARE IN KILOGRAMM

PART NUMBER / DWG NO.:

VLI56

	NAME	SIGNATURE	DATE	REVISION
DRAWN	E.Reispere		28.01.2021	
APPV'D				

DESCRIPTION:

Spring swing LILY

Tiptaptap OÜ

Tiptaptap OÜ
Veetorni 9,
Jüri alevik, Rae vald,
75301 Harjumaa

MATERIAL:

wood, metal, plastic

A4

WEIGHT:

SCALE: 1:25

SHEET 2 OF 5

foundation

A

B

C

D

E

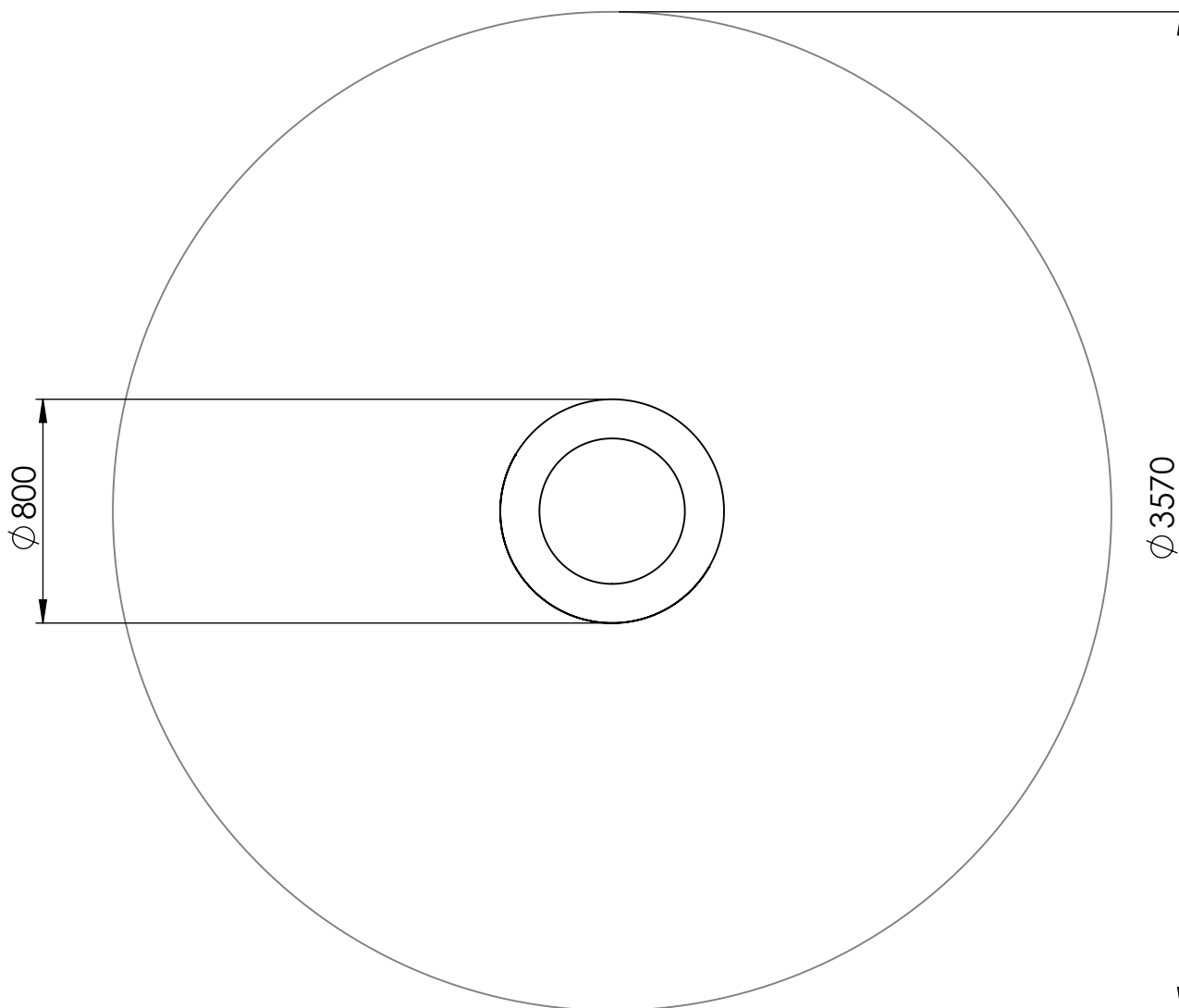

UNLESS OTHERWISE SPECIFIED:
DIMENSIONS ARE IN MILLIMETERS
WEIGHT ARE IN KILOGRAMM

PART NUMBER / DWG NO.:

VLI56

	NAME	SIGNATURE	DATE	REVISION
DRAWN	E.Reispere		28.01.2021	
APPV'D				

DESCRIPTION:

Spring swing LILY

F



Tiptaptap OÜ

Tiptaptap OÜ
Veetorni 9,
Jüri alevik, Rae vald,
75301 Harjumaa

MATERIAL:

wood, metal, plastic

A4

WEIGHT:

SCALE: 1:25

SHEET 3 OF 5

A

B

C

D

E

F

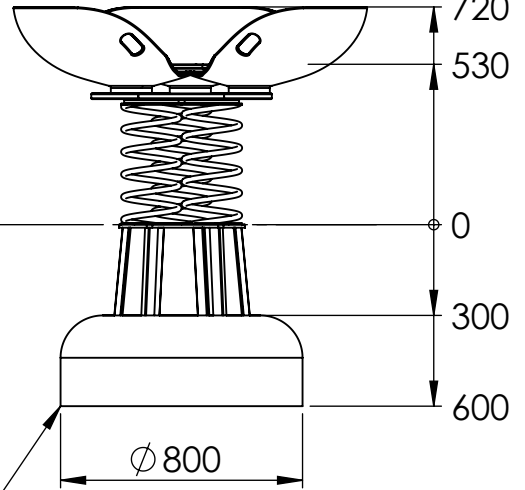
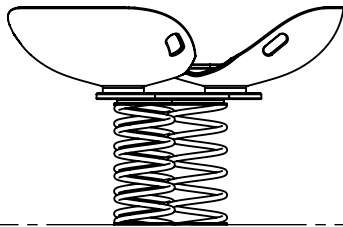

ground

concrete

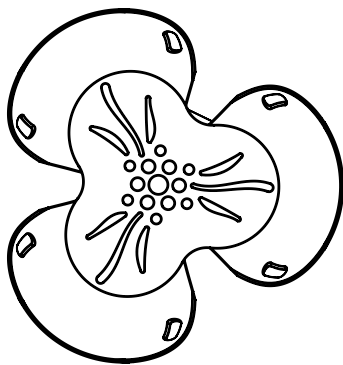

UNLESS OTHERWISE SPECIFIED:
 DIMENSIONS ARE IN MILLIMETERS
 WEIGHT ARE IN KILOGRAMM

PART NUMBER / DWG NO.:

VLI56

	NAME	SIGNATURE	DATE	REVISION
DRAWN	E.Reispere		28.01.2021	
APPV'D				

DESCRIPTION:

Spring swing LILY



Tiptaptap OÜ

Tiptaptap OÜ
 Veetorni 9,
 Jüri alevik, Rae vald,
 75301 Harjumaa

MATERIAL:

wood, metal, plastic

A4

WEIGHT:

SCALE: 1:25

SHEET 4 OF 5

A



1

B

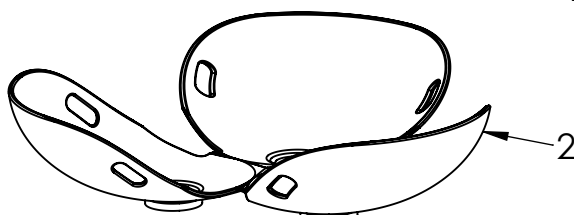

2

C



3



4



5

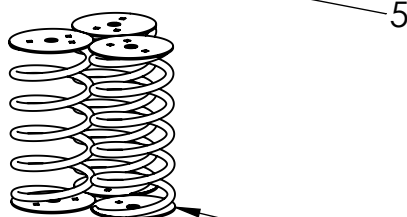

6

D

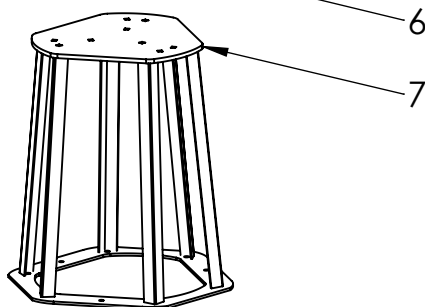

7

ITEM NO.	PART NUMBER	DESCRIPTION	QTY.
1	Lily top plate	HDPE plastic	1
2	bowl	PE plastic	3
3	distance disc Ø160	HDPE plastic	1
4	Lily support plate	HDPE plastic	1
5	distance disc Ø180	HDPE plastic	3
6	spring with spring disk	painted steel	3
7	three springs ground fixing	galvanized steel	1

E

UNLESS OTHERWISE SPECIFIED:
DIMENSIONS ARE IN MILLIMETERS
WEIGHT ARE IN KILOGRAMM

PART NUMBER / DWG NO.:

VLI56

	NAME	SIGNATURE	DATE	REVISION
DRAWN	E.Reispere		28.01.2021	
APPV'D				

DESCRIPTION:

Spring swing LILY

F



Tiptiptap OÜ

Tiptiptap OÜ
Veetorni 9,
Jüri alevik, Rae vald,
75301 Harjumaa

MATERIAL:

wood, metal, plastic

A4

WEIGHT:

SCALE: 1:18

SHEET 5 OF 5